

# Installation, Operation, and Maintenance

## Variable Refrigerant Flow System Mini 4-Way Cassette Indoor Unit Series

**Models:**

4TVB0005B100NC  
4TVB0007B100NC  
4TVB0009B100NC  
4TVB0012B100NC  
4TVB0018B100NC  
4TVB0020B100NC

### SAFETY WARNING

Only qualified personnel should install and service the equipment. The installation, starting up, and servicing of heating, ventilating, and air-conditioning equipment can be hazardous and requires specific knowledge and training. Improperly installed, adjusted or altered equipment by an unqualified person could result in death or serious injury. When working on the equipment, observe all precautions in the literature and on the tags, stickers, and labels that are attached to the equipment.



# Introduction

## Warnings, Cautions, and Notices

Safety advisories appear throughout this manual as required. Your personal safety and the proper operation of this machine depend upon the strict observance of these precautions.

---

The three types of advisories are defined as follows:

 <b>WARNING</b>	Indicates a potentially hazardous situation which, if not avoided, could result in death or serious injury.
 <b>CAUTION</b>	Indicates a potentially hazardous situation which, if not avoided, could result in minor or moderate injury. It could also be used to alert against unsafe practices.
<b>NOTICE</b>	Indicates a situation that could result in equipment or property-damage only accidents.

---

## Important Environmental Concerns

Scientific research has shown that certain man-made chemicals can affect the earth's naturally occurring stratospheric ozone layer when released to the atmosphere. In particular, several of the identified chemicals that may affect the ozone layer are refrigerants that contain Chlorine, Fluorine and Carbon (CFCs) and those containing Hydrogen, Chlorine, Fluorine and Carbon (HCFCs). Not all refrigerants containing these compounds have the same potential impact to the environment. Trane advocates the responsible handling of all refrigerants—including industry replacements for CFCs and HCFCs such as saturated and unsaturated HFCs and HCFCs.

## Important Responsible Refrigerant Practices

Trane believes that responsible refrigerant practices are important to the environment, our customers, and the air conditioning industry. All technicians who handle refrigerants must be certified. The Federal Clean Air Act (Section 608) sets forth the requirements for handling, reclaiming, recovering and recycling of certain refrigerants and the equipment that is used in these service procedures. In addition, some states or municipalities may have additional requirements that must also be adhered to for responsible management of refrigerants. Know the applicable laws and follow them.

### **WARNING**

#### **Proper Field Wiring and Grounding Required!**

**Failure to follow code could result in death or serious injury. All field wiring MUST be performed by qualified personnel. Improperly installed and grounded field wiring poses FIRE and ELECTROCUTION hazards. To avoid these hazards, you MUST follow requirements for field wiring installation and grounding as described in NEC and your local/state electrical codes. Failure to follow code could result in death or serious injury.**

**⚠ WARNING**

**Personal Protective Equipment (PPE) Required!**

Failure to wear proper PPE for the job being undertaken could result in death or serious injury. Technicians, in order to protect themselves from potential electrical, mechanical, and chemical hazards, **MUST** follow precautions in this manual and on the tags, stickers, and labels, as well as the instructions below:

- Before installing/servicing this unit, technicians **MUST** put on all PPE required for the work being undertaken (Examples; cut resistant gloves/sleeves, butyl gloves, safety glasses, hard hat/bump cap, fall protection, electrical PPE and arc flash clothing). **ALWAYS** refer to appropriate Material Safety Data Sheets (MSDS)/Safety Data Sheets (SDS) and OSHA guidelines for proper PPE.
- When working with or around hazardous chemicals, **ALWAYS** refer to the appropriate MSDS/ SDS and OSHA/GHS (Global Harmonized System of Classification and Labelling of Chemicals) guidelines for information on allowable personal exposure levels, proper respiratory protection and handling instructions.
- If there is a risk of energized electrical contact, arc, or flash, technicians **MUST** put on all PPE in accordance with OSHA, NFPA 70E, or other country-specific requirements for arc flash protection, **PRIOR** to servicing the unit. **NEVER PERFORM ANY SWITCHING, DISCONNECTING, OR VOLTAGE TESTING WITHOUT PROPER ELECTRICAL PPE AND ARC FLASH CLOTHING. ENSURE ELECTRICAL METERS AND EQUIPMENT ARE PROPERLY RATED FOR INTENDED VOLTAGE.**

## Copyright

This document and the information in it are the property of Trane, and may not be used or reproduced in whole or in part without written permission. Trane reserves the right to revise this publication at any time, and to make changes to its content without obligation to notify any person of such revision or change.

## Trademarks

All trademarks referenced in this document are the trademarks of their respective owners.

## Revision History

The Digit 14 change to the unit model number represents a firmware revision which enables compatibility between the indoor unit and the second generation outdoor unit (ODU) series: model numbers 4TVH/R\*\*\*\*D, 4TVP\*\*\*\*C); and the second generation mode control unit (MCU) series model numbers 4MCUTV\*\*\*\*A. Additional miscellaneous corrections were made for consistency and accuracy.

# Table of Contents

Model Number Description .....	6
Preparing for Installation .....	7
Accessories .....	7
Location Considerations .....	7
Unit Dimensions .....	8
Service Clearances .....	9
Installation .....	10
Mounting the Unit .....	10
Purging the Unit .....	11
Installing Refrigerant Piping .....	12
Pipe Cutting .....	12
Nitrogen Flushing While Brazing .....	12
Flared Pipe Connections .....	13
Leak Testing Pipe Connections .....	14
Installing the Drain System .....	16
Centralized Drainage .....	18
Testing the Drainage .....	18
Insulation .....	19
Insulating Refrigerant Pipes .....	19
Insulating the Drainage System .....	19
Wiring the Unit .....	20
Power Wiring .....	20
Communications Wiring .....	20
Electrical Conduit Installation .....	20
Configuration .....	23
Using the VRF Technician Utilities Tool (TUT) .....	23
Using the VRF Wireless Remote Control .....	24
The 2-Digit Segments .....	25
Installation Option #1 .....	26
Installation Option #2 .....	28
Operation .....	32
Components .....	32
Operating Tips .....	32
Internal Protections .....	33
Operating Ranges .....	33
Operating Mode for Heat Pump Systems .....	33

---

Maintenance .....	33
Cleaning the Exterior .....	33
Cleaning the Grill and Air Filter .....	34
Periodic Maintenance Checks .....	35
Error Codes .....	35
Troubleshooting .....	35

# Model Number Description

4	T	V	B	0	0	1	8	B	1	0	0	N	C
1	2	3	4	5	6	7	8	9	10	11	12	13	14

## Digit 1: Refrigerant

4 = R410A

## Digit 2: Brand name

T = Trane

## Digit 3: System type

V = Variable Refrigerant Flow

## Digit 4: Configuration Type

B = mini 4-way cassette

## Digit 5: Reserved for future use

0 = Not currently used

## Digit 6, 7, 8: Nominal capacity (Btu/h x 1,000)

005 = 5,000 Btu/h

007 = 7,500 Btu/h

009 = 9,000 Btu/h

012 = 12,000 Btu/h

018 = 18,000 Btu/h

020 = 20,000 Btu/h

## Digit 9: Major development sequence

A = First development sequence

B = Second development sequence

## Digit 10: Electric power supply characteristics

1 = 208-230/60/1

## Digit 11, 12: Reserved for future use

0 = Not currently used

## Digit 13: Region of sale

N = North America (UL or ETL)

## Digit 14: Minor design sequence

A = First development sequence



B = Second design sequence

C = Third design sequence

# Preparing for Installation

## Accessories

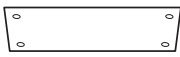
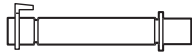
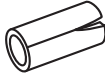
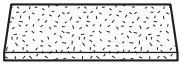
In addition to product literature, the following accessories are supplied with this unit. The type and quantity may differ, depending on the model.

Template	Flexible hose	Drain hose insulation	Drain hose insulation wrap	Conduit bracket	Grommet
					

## Location Considerations

When deciding on a location for the indoor unit, the following factors must be considered:

- The air inlet and outlet must be unobstructed.
- The wall or ceiling must support the weight of the unit.
- The wall or ceiling must not be subject to vibration.
- Pre-plan for easy and short routing of the refrigerant tubing and wiring to the outdoor unit.
- The air must circulate freely in the area to be cooled/heated.
- Sufficient clearance must be maintained around the unit.
- Condensate must be managed correctly and safely away from the unit.
- The unit should be installed in a way that prevents unauthorized access.
- The unit must not be installed in an area that is damp or could come into contact with water (such as a laundry room).
- The unit must not be exposed to direct sunshine or to other direct heat sources.
- The filter must be able to be removed and cleaned easily.
- The unit should be placed as far as possible from fluorescent lights so the remote control is not subject to interference.
- Care should be taken to prevent harmonics generated by loose or unsupported material in close proximity to a running unit.
- The unit must not be installed in an area that is exposed to salt, machine oil, sulfide gas, or corrosive environmental conditions.

## Preparing for Installation

### Unit Dimensions

Unit: inch (mm)

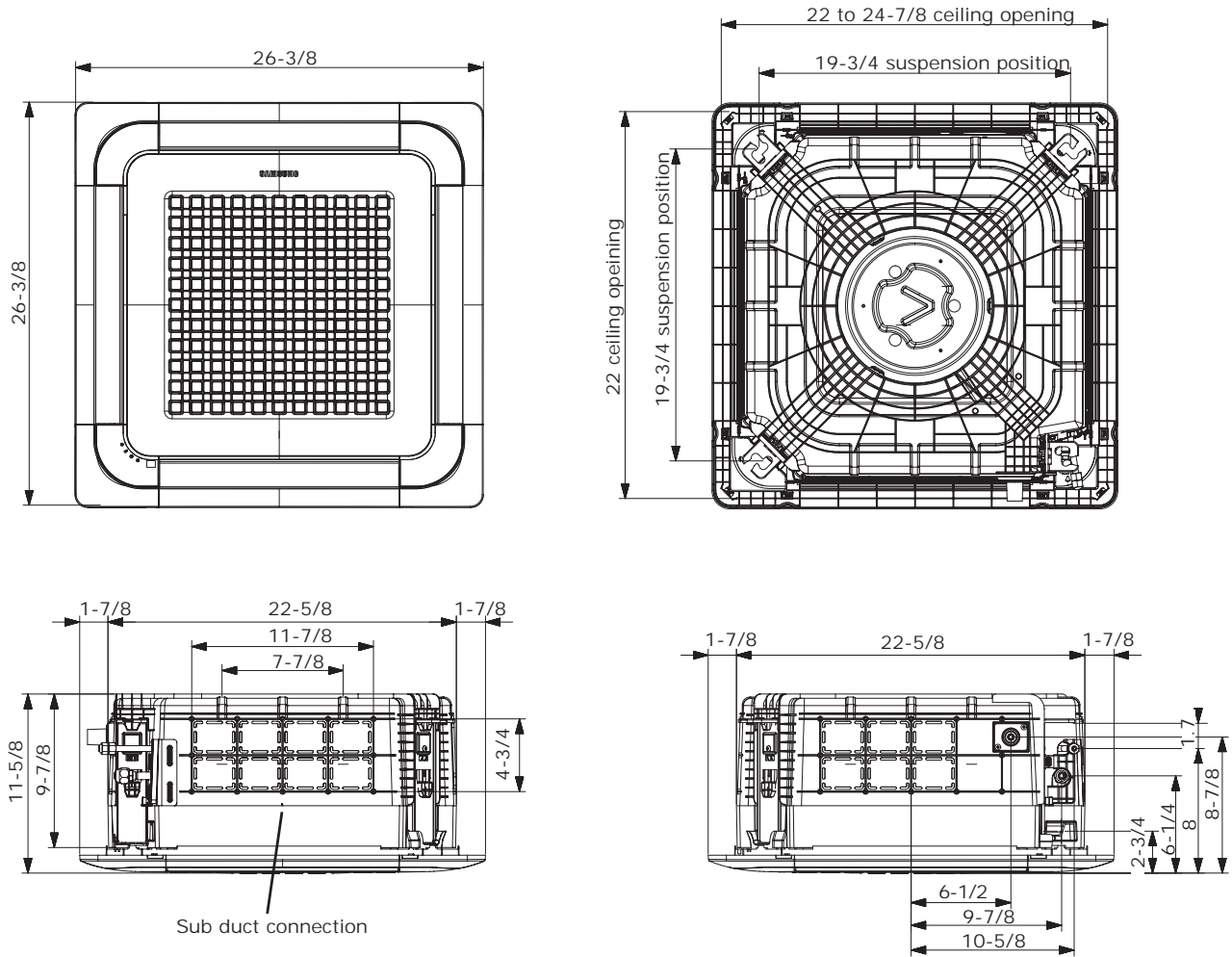

<b>Net dimension</b>	22-5/8 x 9 x 22-5/8
<b>Net weight</b>	24.46 lb
<b>Liquid pipe connection</b>	1/4
<b>Gas pipe connection</b>	1/2
<b>Drain hose connection</b>	OD: 1.25; ID: 0.98



## Service Clearances

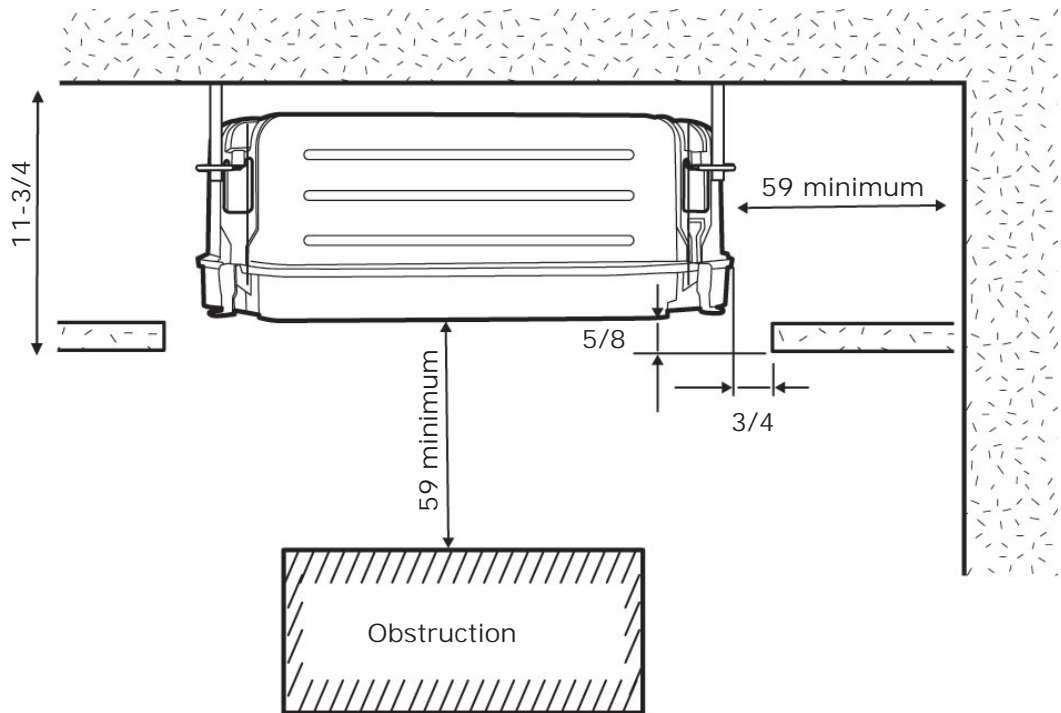

# Installation

Review "Installation Considerations" before proceeding with installation.

Follow the procedures in these sections in the order given.

**Note:** Install the Y-joint before installing the indoor unit.

## Mounting the Unit

If the ceiling is already constructed, piping must be laid into position before placing the unit inside the ceiling.

### ⚠ CAUTION

#### Avoid equipment damage and personal injury!

Ensure that the ceiling is strong enough to support the weight of the indoor unit. Before hanging the unit, test the strength of each of the attached suspension bolts.

To mount the unit:

1. Place the template on the spot where the unit is to be installed and mark the holes.

**Note:** The template may shrink or stretch slightly due to heat or humidity. Before drilling holes, verify proper dimensions between the marks. Refer to "Installing the Front Panel" for final finishing clearances.

2. Determine the appropriate type of suspension bolts and anchors according to the ceiling type. Insert bolt anchors into existing ceiling supports (A) or construct a suitable support (B).

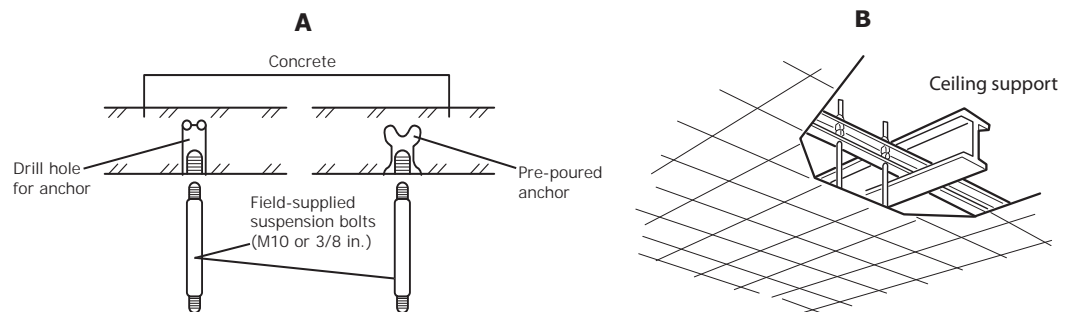

3. Install suspension bolts at all four locations.
4. Screw two nuts to each suspension bolt, leaving space between the nuts for hanging the unit.

**Note:** If the suspension bolts are longer than 59 in.) or vibrations are a concern, place isolators on the brackets to absorb vibrations.

5. Hang the unit by its support brackets between the two nuts.
6. If pad stoppers or isolators are used to absorb vibrations, place them on the brackets.

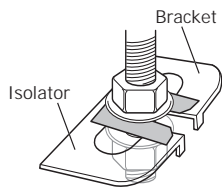

- Tighten the nuts to suspend the unit following the guidelines in the figure below.

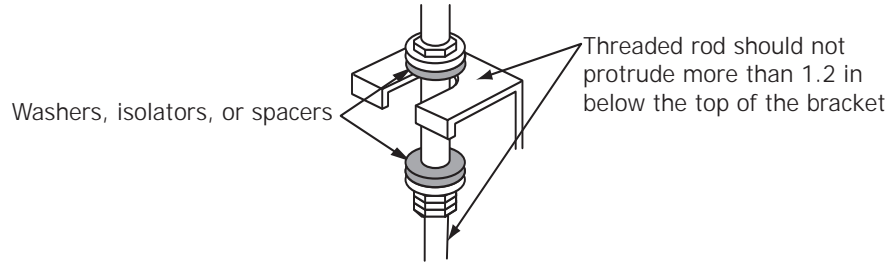

- Maintain proper spacing between the unit and the ceiling; refer to the following figure.

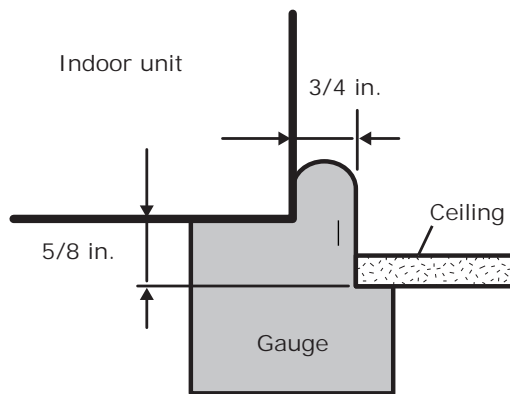

- Adjust the level of the unit with a leveler.

## Purging the Unit

The unit is shipped from the factory with a holding charge of nitrogen. All of this gas must be purged from the unit.

To purge the unit, unscrew the pinch pipes from the ends of both gas and liquid refrigerant pipes. Make sure all gas has escaped before connecting the piping.

**Note:** To prevent dirt or foreign objects from getting into the pipes during installation, do not remove the pinch pipes completely until you are ready to connect the piping.

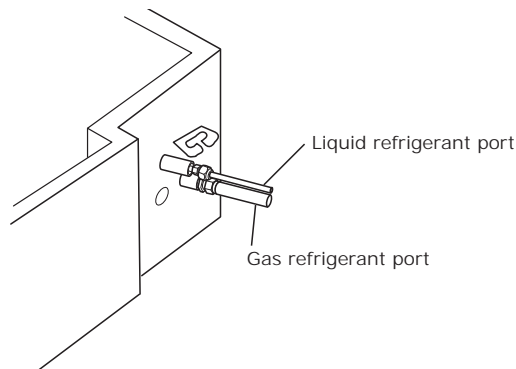

### Installing Refrigerant Piping

Connect field-supplied piping using flared connections (not supplied) or by brazing. The large unit port is for gas refrigerant; the small one is for liquid refrigerant.

Cut or extend field-supplied piping as needed. Use the following procedures.

#### NOTICE

##### System Failure!

**If brazing is used for pipe connections, a nitrogen purge is required to prevent the formation of copper oxides inside the piping. Failure to follow this procedure could damage the system.**

- Before connecting the pipes, make sure they are free of dirt and debris.
- Use insulated, unwelded, degreased, and deoxidized copper pipe (Cu-DHP type according to ISO 1337 or UNI EN 12735-1) suitable for an operating pressure of at least 609.15 psi (4200 kPa) and a burst pressure of at least 3002.28 psi (20,700 kPa). Copper pipe for hydro-sanitary applications is unsuitable.
- For sizing and limits (height difference, line length, maximum bends, refrigerant charge, and so on) see the outdoor unit installation manual.
- All refrigerant connections must be accessible for servicing and maintenance.

### Pipe Cutting

Required tools:

- Pipe cutter
- Reamer
- Pipe holder

1. Using a pipe cutter, cut the pipe so that the cut edge is at 90° to the side of the pipe.
2. Use a reamer to remove all burrs at the cut edge.

See examples of correctly and incorrectly cut pipes.

Correct: 90°

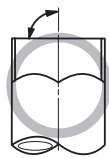

Oblique



Rough



Burr



### Nitrogen Flushing While Brazing

#### NOTICE

##### Avoid Unit Damage!

**Never braise pipe connections without performing nitrogen flushing. Failure to perform this procedure will damage the unit, resulting in capacity loss and reduced long-term reliability.**

While brazing refrigerant pipes, flush them with nitrogen gas. Use a pressure regulator to maintain a flow rate of 1.76 ft<sup>3</sup>/h or more.

Figure 1. Nitrogen flushing while brazing refrigerant pipes

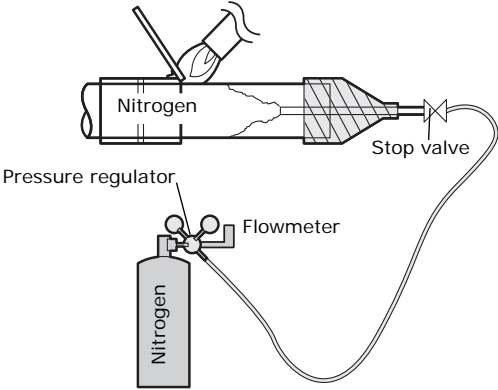

### Flared Pipe Connections

Clutch type and wing nut type flare tools are available for flared pipe connections.

1. Slide the flare nut over the pipe to be flared.
2. Slide the end of the pipe into the hole on the flaring bar that fits the pipe, leaving a length of pipe, determined by tool type (see table), extending above the flaring bar. Clamp it down.

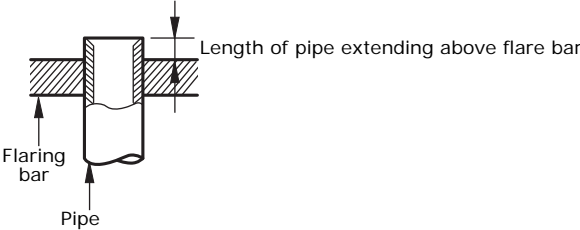

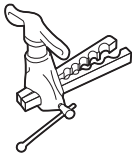
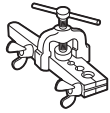
R-410A clutch type	Conventional flare tool	
	Clutch type	Wing nut type
0–0.020 in.	0.04–0.06 in.	0.06–0.08 in.
		

3. Attach the yoke to the flaring bar, centering the conical part over the end of the pipe that is extending above the flaring bar.

## Installation

4. Tighten the yoke securely to flare the end of the pipe.

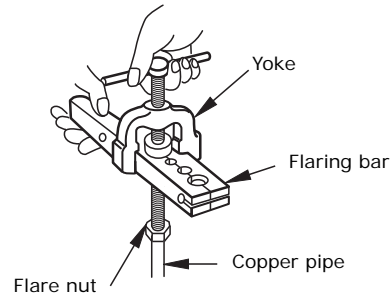

5. Remove the pipe. The end of the pipe that you flared should look like the end of a trumpet. See examples of correctly and incorrectly flared pipes.



6. Align the pipes and tighten the flare nuts manually and then with a spanner torque wrench, applying the torque according to pipe dimensions:

Outer diameter (inch)	Connection torque (ft·lb)	Flare dimension (inch)	Flare shape (in.)
1/4	10.3–13.3 ft·lb	0.34–0.36	
3/8	25.1–31.0 ft·lb	0.50–0.52	
1/2	36.1–45.0 ft·lb	0.64–0.65	
5/8	50.2–60.5 ft·lb	0.76–0.78	

## Leak Testing Pipe Connections

### ⚠ WARNING

#### Confined Space Hazards!

Do not work in confined spaces where refrigerant or other hazardous, toxic or flammable gas may be leaking. Refrigerant or other gases could displace available oxygen to breathe, causing possible asphyxiation or other serious health risks. Some gases may be flammable and or explosive. If a leak in such spaces is detected, evacuate the area immediately and contact the proper rescue or response authority. Failure to take appropriate precautions or to react properly to such potential hazards could result in death or serious injury.

**⚠ WARNING****Explosion Hazard!**

Never use an open flame to detect gas leaks. It could result in an explosion. Use a leak test solution for leak testing. Failure to follow recommended safe leak test procedures could result in death or serious injury or equipment or property-only-damage.

Use only dry nitrogen with a pressure regulator for pressurizing unit. Do not use acetylene, oxygen or compressed air or mixtures containing them for pressure testing. Do not use mixtures of a hydrogen containing refrigerant and air above atmospheric pressure for pressure testing as they may become flammable and could result in an explosion. Refrigerant, when used as a trace gas should only be mixed with dry nitrogen for pressurizing units. Failure to follow these recommendations could result in death or serious injury or equipment or property-only damage.

Do not exceed unit nameplate design pressures when leak testing system. Failure to follow these instructions could result in an explosion causing death or serious injury.

**Notes:**

- All required piping pressure tests must be completed in accordance with national and/or local codes.
  - When leak-testing refrigerant systems, observe all safety precautions.
  - Leak test only one circuit at a time to minimize system exposure to potentially harmful moisture in the air.
  - Use R-410A refrigerant gas as a tracer for leak detection and use oil-pumped dry nitrogen to develop required test pressures.
1. Close liquid line angle valve.
  2. Connect R-410A refrigerant cylinder to high side charging port (at condenser or field supplied discharge line access port). Add refrigerant to reach pressure of 12 to 15 psig.
  3. Disconnect refrigerant cylinder. Connect dry nitrogen cylinder to high side charging port and increase pressure to 150 psig. Do not exceed high side (discharge) unit nameplate design pressure. Do not subject low side (suction) components to high side pressure.
  4. Check all piping joints, valves, etc. for leaks. Recommend using electronic detector capable of measuring 0.1 oz/year leak rate.
  5. If a leak is located, use proper procedures to remove the refrigerant/nitrogen mixture, break connections and make repairs. Retest for leaks.
  6. Make sure all service valves are open.

## Installing the Drain System

1. Push the supplied drain hose as far as possible over the drain hose port.
  - Do not apply excessive force to the piping on the unit side when connecting the drain hose.
  - Drain hose port locations differ depending on the unit type.

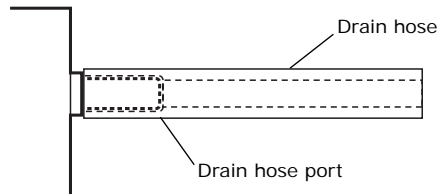

2. Wrap the insulation (supplied) around the drain hose and clamp the connection as tightly as possible until you can see at least 8 holes.

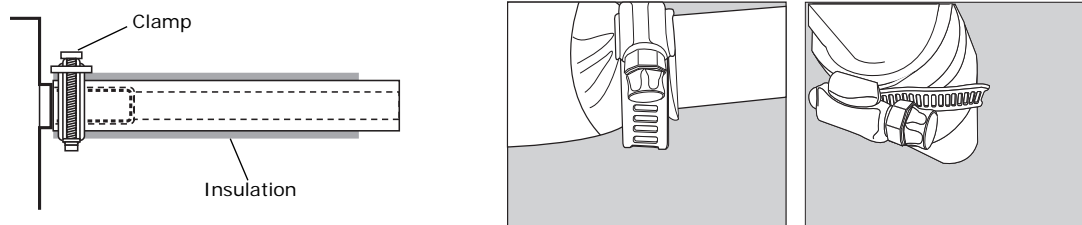

3. Install the drain pipe into the drain hose. Secure it with PVC adhesive and clamps as necessary to ensure a tight fit with no leakage.

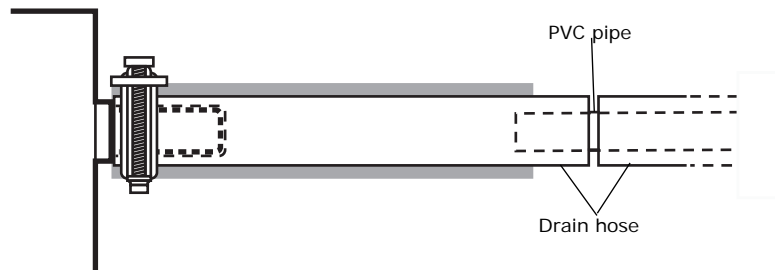

4. Install air vent to ensure smooth condensate drainage.

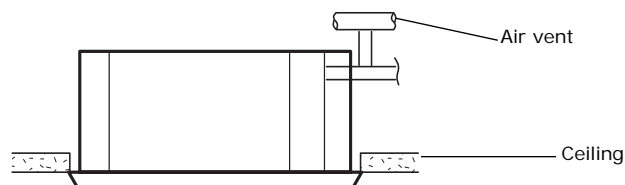



- Do not install the hose with an upward gradient after the connection port or leaks will result.

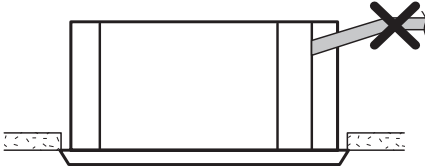

- The hose should not be allowed to hang loose from its connection to the unit. Fasten the hose to a wall, frame or other support as close to the unit as possible.

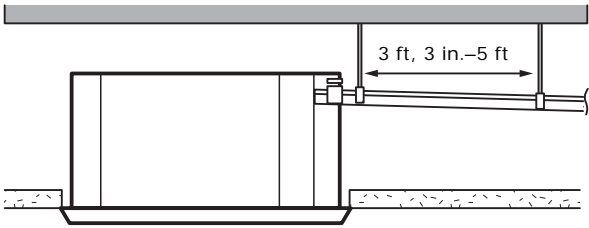

- If increasing the height of the drain pipe is necessary to set the drain hose at a sufficient slope, installing a vertical drain pipe within 11.8 in. from the drain hose port (see A). If raised higher than 21.65 in. , water leaks may result (see "C" in figure).
- Install the air vent at least 3.04 in. above the highest point of the drain pipe.

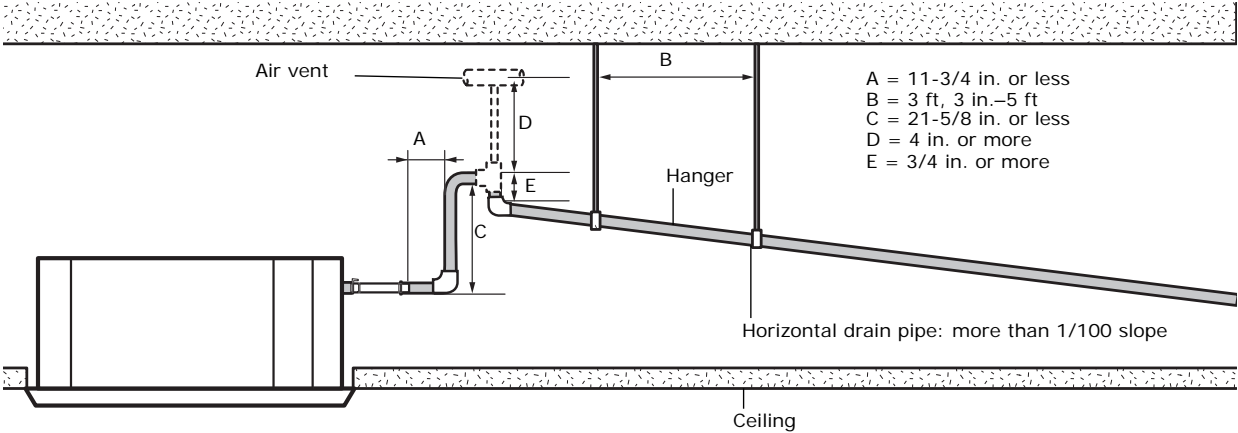

## Centralized Drainage

If the installation requires more than three indoor units, install the main air vent at the front of the indoor unit that is farthest from the main drain.

It may be necessary to install individual air vents to prevent water flowing back to each indoor unit. See figure below.

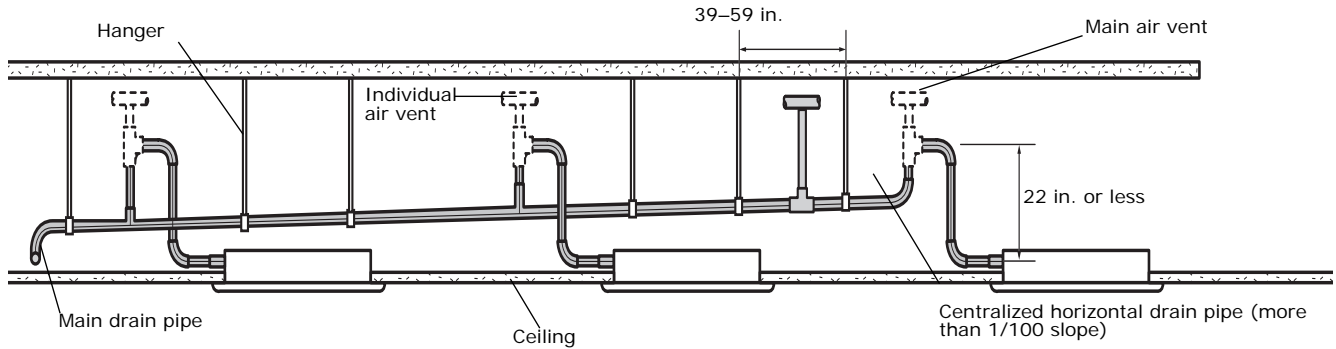

## Testing the Drainage

After completing the installation, test the drainage to make sure there are no leaks:

1. Operate the unit in cool mode.
2. Remove drain pump cover.
3. Squirt water into the drain pan (as shown in the next figure).

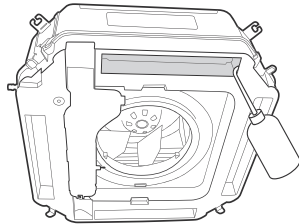

4. Confirm that the water flows out through the drain hose and that no leakage occurs at any of the connections.
5. Reassemble the drain pump cover.

# Insulation

After determining that there are no leaks in the refrigerant pipes or drainage hose, insulate them as described in these sections.

## Insulating Refrigerant Pipes

1. Use the table below to select the insulation type for each pipe size.

Pipe	Pipe size (inch)	Insulation Type	
		Standard conditions (86°F [30°C], 85%)	High humidity conditions <sup>(a)</sup> (86°F [30°C], over 85%)
		EPDM or NBR	
Liquid pipe	1/4 – 3/8	3/8	3/8
	1/2 – 2	1/2	1/2
Gas pipe <sup>(b)</sup>	1/4	1/2	3/4
	3/8– 1	3/4	1.0
	1-1/8– 1-3/4		1-1/4
	2	1.0	1-1/2

- (a) When installing insulation in any of the following environments, use insulation required for high humidity conditions: Buildings with close proximity to bodies of water or hot springs or on the side of a hill in which the building is partly covered by earth; ceilings frequently exposed to moisture such as in restaurants, saunas, swimming pools, and corridors of dormitories or studios near a frequently-used outdoor exit; buildings with no ventilation system.
- (b) Internal temperature of gas pipe is higher than 248°F (120°C).

2. Wrap insulation around the entire surface of each pipe, from the indoor unit to the outdoor unit, overlapping insulation to avoid gaps. Clamp insulation tightly to pipe.

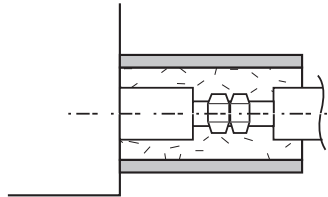

- Do not wrap the gas and liquid refrigerant pipes together.

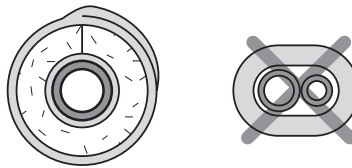

- Avoid compressing the insulation as much as possible.
- Be sure there are no cracks or deformities in the insulation at bends in pipes.
- If necessary double the insulation to prevent condensation from forming in warm or humid areas.
- Cut off excess insulation.

## Insulating the Drainage System

Insulate (field supplied) the entire surface of the drain pipe that is inside the building, including the connection between the drain hose and drain stub. Clamp tightly.

# Wiring the Unit

Observe the following precautions when making electrical connections.

### **⚠ WARNING**

#### **Hazardous Voltage!**

**Disconnect all electric power, including remote disconnects before servicing. Follow proper lockout/tagout procedures to ensure the power can not be inadvertently energized. Failure to disconnect power before servicing could result in death or serious injury.**

### **NOTICE**

#### **Use Copper Conductors Only!**

**Unit terminals are not designed to accept other types of conductors. Failure to use copper conductors could result in equipment damage.**

- Make all electrical connections in accordance with electrical codes and ordinances.
- Select the power cable in accordance with relevant local and national regulations.
- Wire size must comply with local and national code.
- Use grade H07RN-F or H05RN-F power cable.
- Connect the power cable into the power cable terminal and fasten it with a clamp.
- Unbalanced power must be maintained within 10% of supply rating among whole indoor units.
- Significantly unbalanced power may shorten the life of the system. If the unbalanced power is greater than 10% of supply rating, the unit will stop and an error code will be generated.
- Connect the power cable to the auxiliary circuit breaker. An all-pole disconnection from the power supply must be incorporated in the field wiring (1/8 in.).
- All wiring must be protected from weather and damage.
- Maintain a distance of 2 in. or more between power and communications cables to prevent interference.
- Maintain a voltage drop of less than 10% between the power source and the unit(s).
- Use an appropriate screwdriver for tightening the terminal screws. A screwdriver with a small head will strip the head and make proper tightening impossible.
- Over-tightening the terminal screws may break them.  
Tightening torque for M4 screws: 0.86–1.06 lbf-ft.
- After making a knockout hole, apply rust-preventive paint to the bare metal around the hole.
- Secure the cable conduit to the outdoor knockout using the proper connector and bushing.

## Power Wiring

Connect the power cable to terminals 1(L) and 2(N) on each indoor unit. Refer to [Figure 2](#) or [Figure 3](#), p. 21.

## Communications Wiring

Use 18 AWG, 25 pF/ft nom., 60.7  $\Omega$  impedance, braid or foil shielded, twisted pair wire. Connect the communications wiring as shown in [Figure 2](#) or [Figure 3](#), p. 21.

## Electrical Conduit Installation

A conduit bracket must be installed to secure the conduit, as illustrated in [Figure 4](#), p. 22.

Figure 2. Wiring diagram for individual control

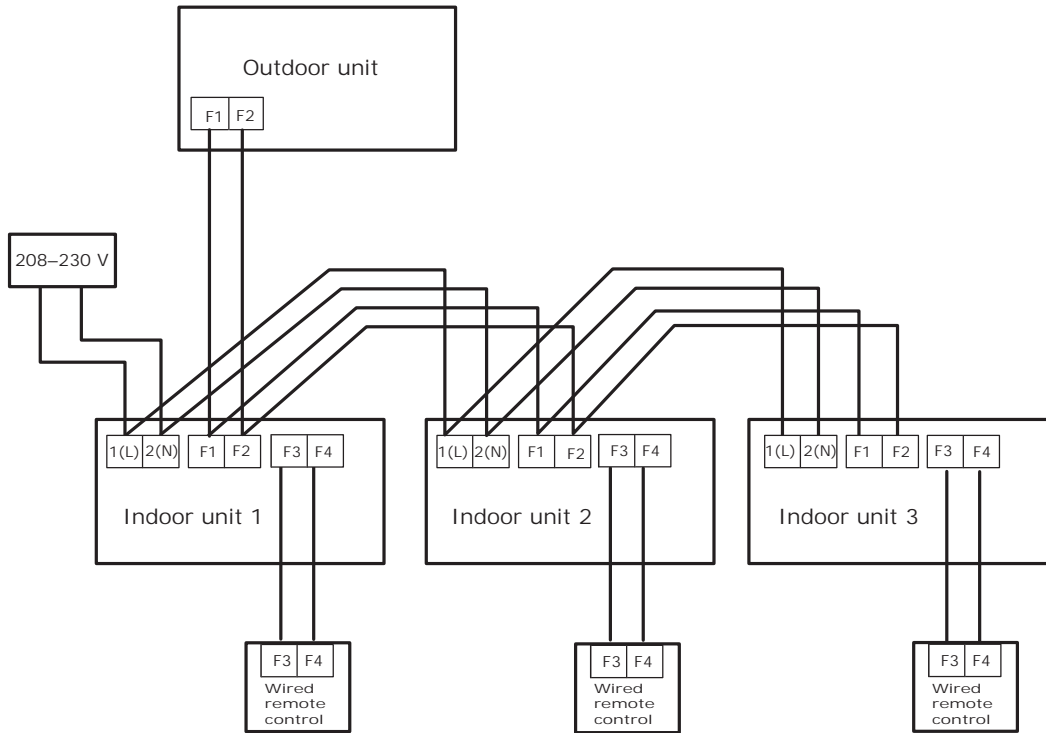
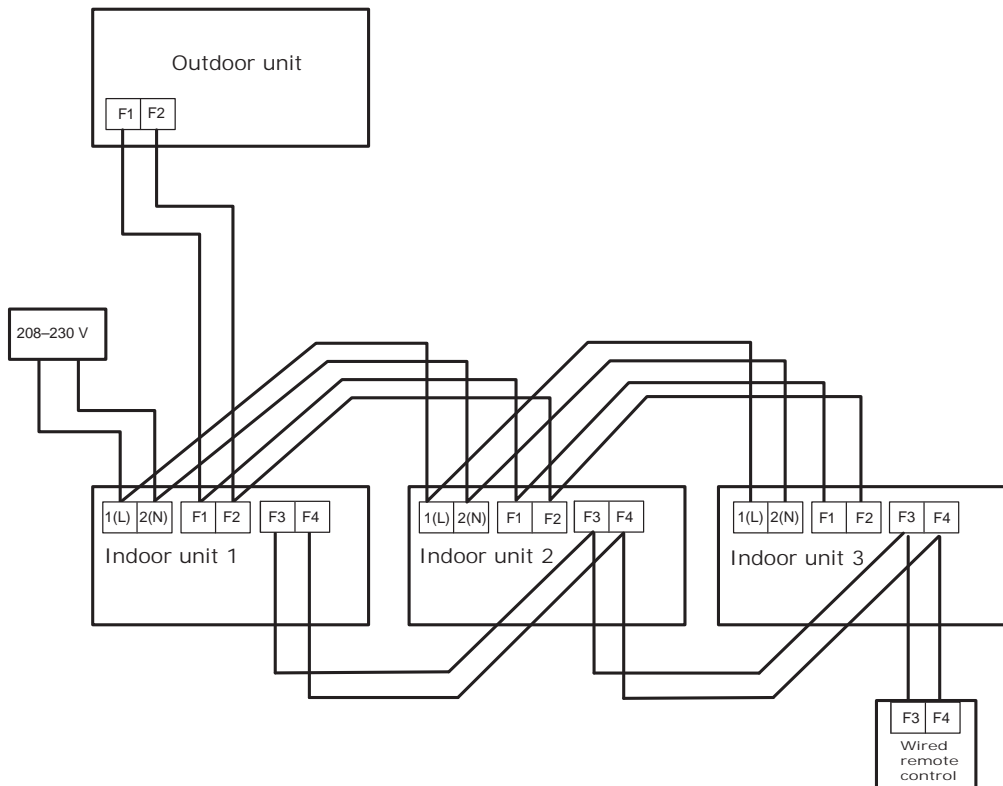
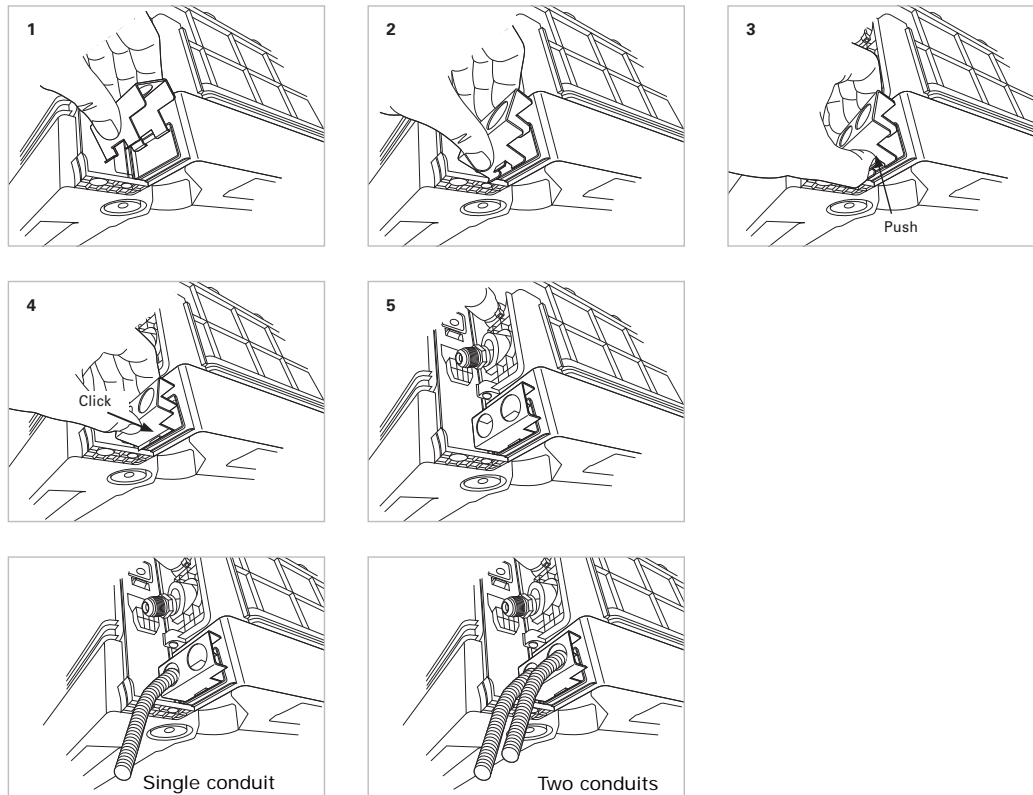

Figure 3. Wiring diagram for group control



**Figure 4. Conduit bracket installation**



# Configuration

All VRF indoor units are factory configured. If modifications are required, the Technician Utilities Tool (TUT) is strongly recommended. However, any of the following devices can be used:

- VRF Technician Utilities Tool (TUT) (instructions follow)
- VRF Wireless Remote Control (instructions follow)
- VRF Wired Remote Control (refer to VRF-SVN59\* for instructions)

**Note:** Configuration changes are not required for typical installations.

## Using the VRF Technician Utilities Tool (TUT)

To change configurations using the VRF Technician Utilities Tool (TUT), follow this procedure:

1. At the Indoor Unit Option Writer screen on the TUT, select the desired option codes by referring to [Table 1, p. 26](#) and [Table 2, p. 28](#).

In addition, use the following table and notes to determine which digits can be modified.

	Digit						Digit					
	1	2	3	4	5	6	7	8	9	10	11	12
Installation Option #1	[0]	2	0	0	1	0	[1]	0	0	0	0	0
Installation Option #2	[0]	5	0	0	0	0	[1]	0	0	0	0	0

  

	Digit						Digit					
	13	14	15	16	17	18	19	20	21	22	23	24
Installation Option #1	[2]	0	0	0	0	0	[3]	0	0	0	0	0
Installation Option #2	[2]	0	0	0	0	0	[3]	0	0	0	0	0

**Notes:**

1. Digits 1, 7, 13 and 19 (in brackets) are factory set and cannot be changed.
2. For Installation Option #1, digit 2 will always be "2". See [Table 1](#) for the option code settings.
3. For Installation Option #2, digit 2 will always be "5". See [Table 2](#) for the option code settings.
4. Digits shown in black boxes are currently not used and should always be set to "0".

2. To save your settings, select the **Write Option** button. See the figure below for an example of the Indoor Unit Option Writer screen on the TUT.

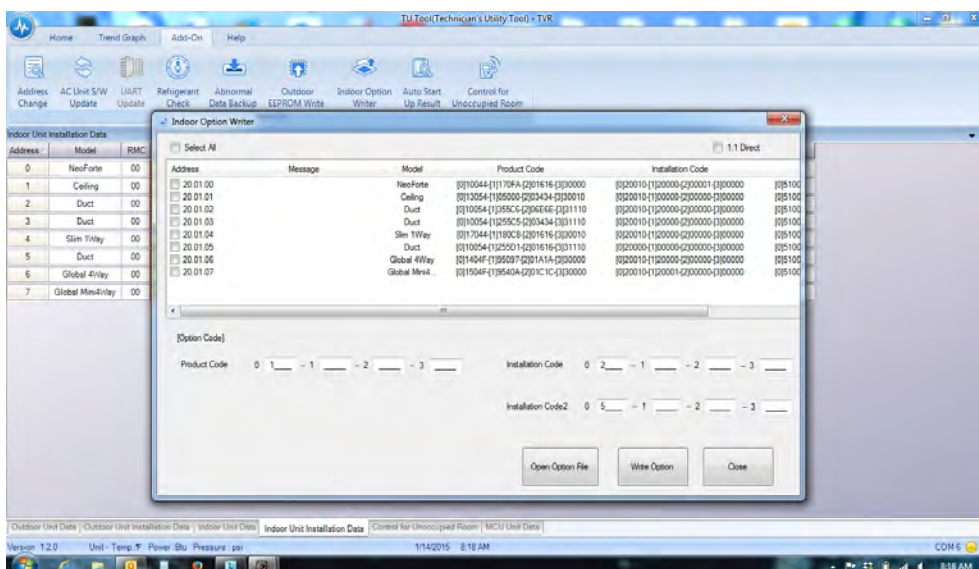

## Using the VRF Wireless Remote Control

To change configurations of the VRF system using the VRF Wireless Remote Control, follow this procedure:

1. Remove the batteries from the remote control, and re-insert them while simultaneously pressing the Temp+ and Temp- buttons (refer to Figure 5).

The first 2-digit segment of a 24-digit sequence will appear on the wireless remote control display, as shown:

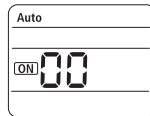

2. To advance to the next 2-digit segment, press the Mode button (Figure 5). Continue pressing the Mode button until the two-digit segment appears that corresponds to the option setting or address setting you want to view or change.

Each 2-digit segment is differentiated from the others by a combination of operation mode (Auto/Cool/Dry...) and ON/OFF icons, as shown below. (See “The 2-Digit Segments,” for more detailed information.)

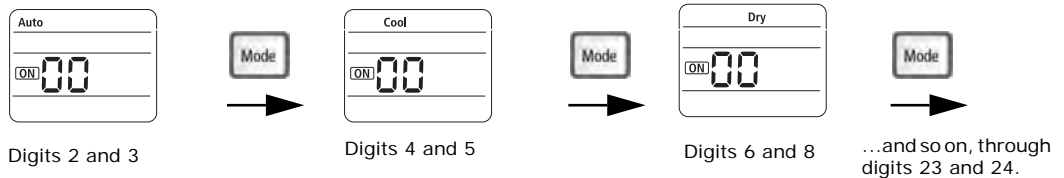

**Note:** Digits 1, 7, 13, and 19 do not appear and are not used for configuration.

3. To change the value of the left digit on the display, press the Fan down button.  
To change the value of the right digit on the display, press the Fan up button.

**Note:** Values and their corresponding settings are listed in the following pages of this section of the manual.

4. To save the setting, press the Power button twice.
5. To restore the wireless remote control to normal operating mode, remove the batteries from the remote control. Then re-insert them.

**Figure 5. VRF Wireless Remote Control**

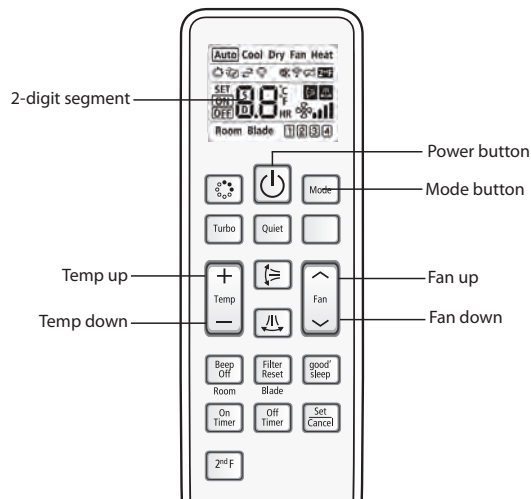



## The 2-Digit Segments

Each 2-digit segment is differentiated from the others by a combination of operation mode and timer on/off icons as shown in Figure 6.

Use digit 2 (shown in red in Figure 6) to set the wireless remote to Installation Option #1.

**Figure 6. Two-digit segments in the 24-digit sequenc**

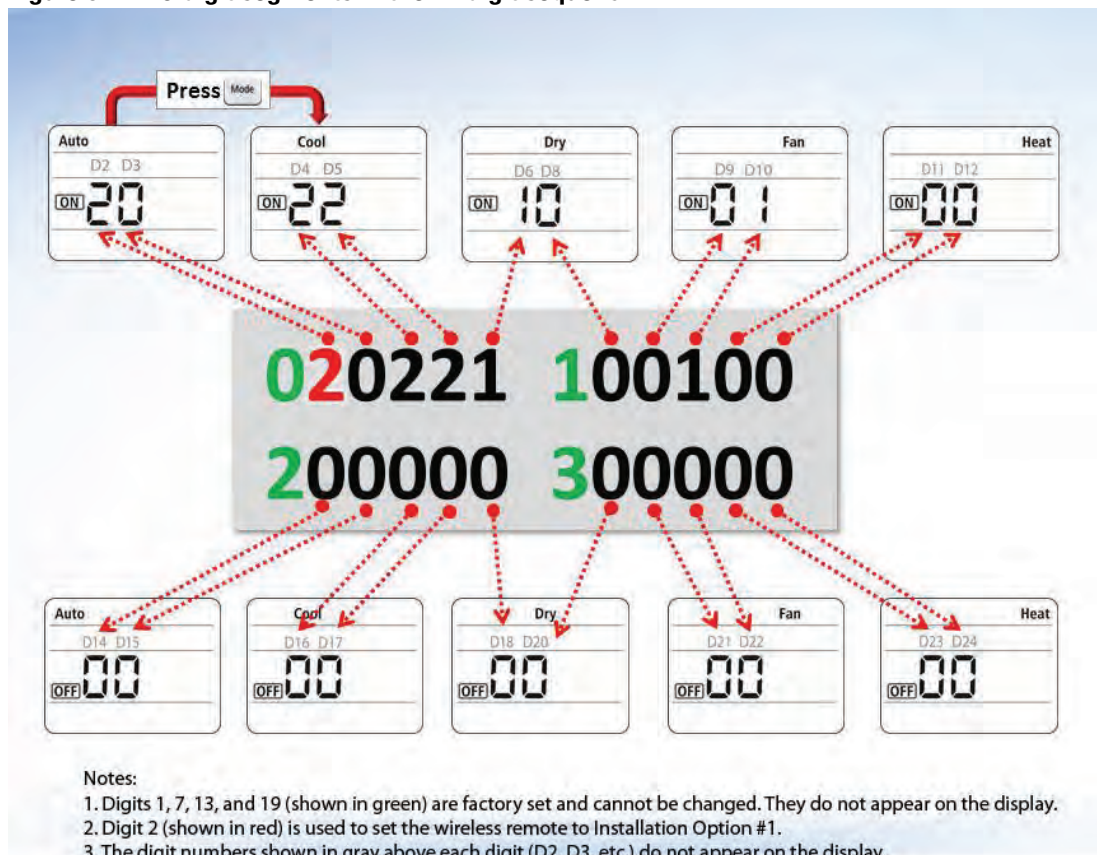

**Notes:**

1. Digits 1, 7, 13, and 19 (shown in green) are factory set and cannot be changed. They do not appear on the display.
2. Digit 2 (shown in red) is used to set the wireless remote to Installation Option #1.
3. The digit numbers shown in gray above each digit (D2, D3, etc.) do not appear on the display.

## Configuration

### Installation Option #1

When **digit 2** is set to a value of “2,” the options shown in [Table 1](#) can be set to the values in the right column.

**Table 1. Installation option #1: Digit 2 = 2**

Display screen (mode and On/Off)	Digit	Option description	Set digit to...																										
N/A	1	Factory set to 0	Cannot be changed. Not seen in configuration mode.																										
	2	Installation option #1	2																										
	3	Evaporator Drying	0: Disabled 1: Disabled 2: Enabled (5 min) 3: Disabled (5 min) 4: Enabled (10 min) 5: Disabled (10 min) 6: Enabled (30 min) 7: Disabled (30 min) <b>Note:</b> When Cooling or Dry mode stops, the indoor fan continues to operate for the number of minutes indicated by each setting.																										
	4	Remote temperature sensor/ minimizing fan operation when thermostat is Off	<table border="0"> <tr> <td><b>Remote temperature sensor</b></td> <td><b>Minimizing fan operation when unit is Thermo Off</b></td> </tr> <tr> <td>0: Disabled</td> <td>Disabled</td> </tr> <tr> <td>1: Enabled</td> <td>Disabled</td> </tr> <tr> <td>2: Disabled</td> <td>Enabled (Heating)<sup>(a)</sup></td> </tr> <tr> <td>3: Enabled</td> <td>Enabled (Heating)<sup>(a)</sup></td> </tr> <tr> <td>4: Disabled</td> <td>Enabled (Cooling)<sup>(a)</sup></td> </tr> <tr> <td>5: Enabled</td> <td>Enabled (Cooling)<sup>(a)</sup></td> </tr> <tr> <td>6: Disabled</td> <td>Enabled (Heating/Cooling)<sup>(a)</sup></td> </tr> <tr> <td>7: Enabled</td> <td>Enabled (Heating/Cooling)<sup>(a)</sup></td> </tr> <tr> <td>8: Disabled</td> <td>Enabled (Cooling Ultra Low Fan)<sup>(a)</sup></td> </tr> <tr> <td>9: Enabled</td> <td>Enabled (Cooling Ultra Low Fan)<sup>(a)</sup></td> </tr> <tr> <td>A: Disabled</td> <td>Enabled (Heating/Cooling Ultra Low Fan)<sup>(a)</sup></td> </tr> <tr> <td>B: Enabled</td> <td>Enabled (Heating/Cooling Ultra Low Fan)<sup>(a)</sup></td> </tr> </table> <p><sup>(a)</sup> Minimizes fan operation when unit is Thermo Off. Fan operates for 20 seconds at an interval of 5 minutes in Heat mode. Fan stops or operates in Ultra Low in Cooling mode when unit is Thermo Off.</p>	<b>Remote temperature sensor</b>	<b>Minimizing fan operation when unit is Thermo Off</b>	0: Disabled	Disabled	1: Enabled	Disabled	2: Disabled	Enabled (Heating) <sup>(a)</sup>	3: Enabled	Enabled (Heating) <sup>(a)</sup>	4: Disabled	Enabled (Cooling) <sup>(a)</sup>	5: Enabled	Enabled (Cooling) <sup>(a)</sup>	6: Disabled	Enabled (Heating/Cooling) <sup>(a)</sup>	7: Enabled	Enabled (Heating/Cooling) <sup>(a)</sup>	8: Disabled	Enabled (Cooling Ultra Low Fan) <sup>(a)</sup>	9: Enabled	Enabled (Cooling Ultra Low Fan) <sup>(a)</sup>	A: Disabled	Enabled (Heating/Cooling Ultra Low Fan) <sup>(a)</sup>	B: Enabled	Enabled (Heating/Cooling Ultra Low Fan) <sup>(a)</sup>
<b>Remote temperature sensor</b>	<b>Minimizing fan operation when unit is Thermo Off</b>																												
0: Disabled	Disabled																												
1: Enabled	Disabled																												
2: Disabled	Enabled (Heating) <sup>(a)</sup>																												
3: Enabled	Enabled (Heating) <sup>(a)</sup>																												
4: Disabled	Enabled (Cooling) <sup>(a)</sup>																												
5: Enabled	Enabled (Cooling) <sup>(a)</sup>																												
6: Disabled	Enabled (Heating/Cooling) <sup>(a)</sup>																												
7: Enabled	Enabled (Heating/Cooling) <sup>(a)</sup>																												
8: Disabled	Enabled (Cooling Ultra Low Fan) <sup>(a)</sup>																												
9: Enabled	Enabled (Cooling Ultra Low Fan) <sup>(a)</sup>																												
A: Disabled	Enabled (Heating/Cooling Ultra Low Fan) <sup>(a)</sup>																												
B: Enabled	Enabled (Heating/Cooling Ultra Low Fan) <sup>(a)</sup>																												
	5	Central control	0: Disabled 1: Enabled																										
	6	RPM up	0: Disabled 1: Enabled																										
N/A	7	Factory set to 1	Cannot be changed. Not seen in configuration mode.																										
	8	Drain pump	0: Disabled 1: Enabled (no delay) 2: Enabled (3-min delay)																										

Table 1. Installation option #1: Digit 2 = 2 (continued)

Display screen (mode and On/Off)	Digit	Option description	Set digit to...														
	11	Adjusted EEV position of Thermo Off unit	0: Default EEV position 1: Reduced EEV position														
N/A	13	Factory set to 2	Cannot be changed. Not seen in configuration mode.														
	14	External control relay	0: Disabled 1: On/off control 2: Off-only control 3: Window on/off control														
	15	External control output/ External heater signal/ Cooling operation signal/ Free cooling control signal <sup>(a)</sup>	0: External control (Thermo On) 1: External control (Operation On) 2: External heater signal (Fan on) <sup>(a)</sup> 3: External heater signal (Fan off) <sup>(b)</sup> 4: Cooling operation signal <sup>(c)</sup> 5: Free Cooling control (Cooling Thermo On) 6: Free Cooling control (Cooling/Dry Thermo On)  <sup>(a)</sup> When used as external heater On/Off signal, the fan runs continually when the external heater is On. <sup>(b)</sup> When used as external heater On/Off signal, the fan is Off when the external heater is On with indoor unit in Cooling Only. (For Cooling Only mode, install the mode selector (TVCTRLTCMC2000) on the outdoor unit and set it to Cooling mode.) If the fan is set to Off and the unit is in Cooling Only mode, an external sensor or wired remote controller is required to detect the current indoor temperature. <sup>(c)</sup> When the indoor unit is in Cooling or Dry mode, the contacts are closed.														
	17	Buzzer	0: Enabled 1: Disabled														
	18	Filter timer (hours of use)	2: 1000 6: 2000														
N/A	19	Factory set to 3	Cannot be changed. Not seen in configuration mode.														
	20	Associating wireless remote control with indoor unit(s)	0, 1: Channel 1 2: Channel 2 3: Channel 3 4: Channel 4														
	21	Heat setting compensation	<table border="0"> <tr> <td><b>Heat setting compensation</b></td> <td><b>Removing condensate in heating mode<sup>(a)</sup></b></td> </tr> <tr> <td>0: Disabled</td> <td>Disabled</td> </tr> <tr> <td>1: 3.6°F (2°C)</td> <td>Disabled</td> </tr> <tr> <td>2: 9°F (5°C)</td> <td>Disabled</td> </tr> <tr> <td>3: Disabled</td> <td>Enabled</td> </tr> <tr> <td>4: 3.6°F (2°C)</td> <td>Enabled</td> </tr> <tr> <td>5: 9°F (5°C)</td> <td>Enabled</td> </tr> </table> <p><sup>(a)</sup> The fan operates (20 min. maximum), even after the indoor unit is turned off, to remove condensate from an indoor unit that has switched from cooling to heating mode. Applies to drain pump models only.</p>	<b>Heat setting compensation</b>	<b>Removing condensate in heating mode<sup>(a)</sup></b>	0: Disabled	Disabled	1: 3.6°F (2°C)	Disabled	2: 9°F (5°C)	Disabled	3: Disabled	Enabled	4: 3.6°F (2°C)	Enabled	5: 9°F (5°C)	Enabled
<b>Heat setting compensation</b>	<b>Removing condensate in heating mode<sup>(a)</sup></b>																
0: Disabled	Disabled																
1: 3.6°F (2°C)	Disabled																
2: 9°F (5°C)	Disabled																
3: Disabled	Enabled																
4: 3.6°F (2°C)	Enabled																
5: 9°F (5°C)	Enabled																

## Configuration

**Table 1. Installation option #1: Digit 2 = 2 (continued)**

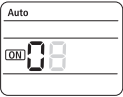
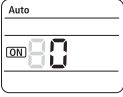
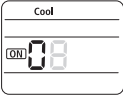
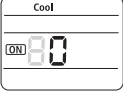
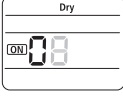
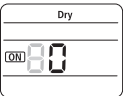
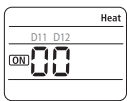
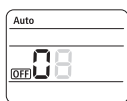
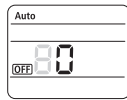
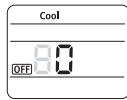
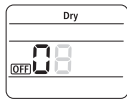
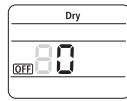
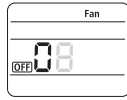
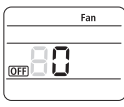
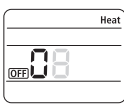
Display screen (mode and On/Off)	Digit	Option description	Set digit to...
	22	Adjusted EEV position of Thermo Off unit during oil return/defrost mode	0: Default EEV position 1: Reduced EEV position
	23	Motion detection sensor	0: Disabled 1: Disabled in 30 minutes if no motion is detected 2: Disabled in 60 minutes if no motion is detected 3: Disabled in 120 minutes if no motion is detected 4: Disabled in 180 minutes if no motion is detected 5: Disabled in 30 minutes if no motion is detected and advanced function <sup>(b)</sup> 6: Disabled in 60 minutes if no motion is detected and advanced function 7: Disabled in 120 minutes if no motion is detected and advanced function 8: Disabled in 180 minutes if no motion is detected and advanced function

(a) Digit 15 requires that an external contact interface module be connected. Refer to VRF-SVN54\*.

(b) Advanced function: Controls heating/cooling or power saving with motion detector.

## Installation Option #2

When **digit 2** is set to a value of "5," the options shown in [Table 2](#) can be changed to the values in the right column.

**Table 2. Installation option #2: Digit 2 = 5**

Display screen (mode and On/Off)	Digit	Option description	Set digit to...
N/A	1	Factory set to 0	Cannot be changed. Not seen in configuration mode.
	2	Installation option #2	5
	3	Auto Changeover (Heat Recovery or Cooling Only)	0: Follow product option 1: Auto Changeover enabled (see <a href="#">Figure 7, p. 31</a> ). <sup>(a)</sup> 2: Cooling Only enabled (see <a href="#">Figure 7, p. 31</a> ). <sup>(b)</sup>
	4	Heating deadband <b>Note:</b> Applies only when digit 3 is set to "1" (Auto Changeover mode is enabled).	0: Disabled 1: 0.9°F (0.5°C) 2: 1.8°F (1°C) 3: 2.7°F (1.5°C) 4: 3.6°F (2°C) 5: 4.5°F (2.5°C) 6: 5.4°F (3°C) 7: 6.3°F (3.5°C)
	5	Cooling deadband <b>Note:</b> Applies only when digit 3 is set to "1" (Auto Changeover mode is enabled).	0: Disabled 1: 0.9°F (0.5°C) 2: 1.8°F (1°C) 3: 2.7°F (1.5°C) 4: 3.6°F (2°C) 5: 4.5°F (2.5°C) 6: 5.4°F (3°C) 7: 6.3°F (3.5°C)

Table 2. Installation option #2: Digit 2 = 5

Display screen (mode and On/Off)	Digit	Option description	Set digit to...																																
	6	Standard for Auto Changeover (heating to cooling) <b>Note:</b> Applies only when digit 3 is set to "1" (Auto Changeover mode is enabled).	0: 1.8°F (1°C) 1: 2.7°F (1.5°C) 2: 3.6°F (2°C) 3: 4.5°F (2.5°C) 4: 5.4°F (3°C) 5: 6.3°F (3.5°C) 6: 7.2°F (4°C) 7: 8.1°F (4.5°C)																																
N/A	7	Factory set to 1	Cannot be changed. Not seen in configuration mode.																																
	8	Standard for Auto Changeover (cooling to heating) <b>Note:</b> Applies only when digit 3 is set to "1" (Auto Changeover mode is enabled).	0: 1.8°F (1°C) 1: 2.7°F (1.5°C) 2: 3.6°F (2°C) 3: 4.5°F (2.5°C) 4: 5.4°F (3°C) 5: 6.3°F (3.5°C) 6: 7.2°F (4°C) 7: 8.1°F (4.5°C)																																
	9	Time required for mode change <b>Note:</b> Applies only when digit 3 is set to "1" (Auto Changeover mode is enabled).	0: 5 minutes 1: 7 minutes 2: 9 minutes 3: 11 minutes 4: 13 minutes 5: 15 minutes 6: 20 minutes 7: 30 minutes																																
	10	Compensation option for height or pipe length difference between indoor units	0: Use default value 1: Use when height or pipe length difference is as specified. <sup>(c)</sup> 2: Use when height or pipe length difference is as specified. <sup>(d)</sup>																																
N/A	13	Factory set to 2	Cannot be changed. Not seen in configuration mode.																																
	18 <sup>(e)</sup>	Control variables for auxiliary heat	<table border="0"> <thead> <tr> <th>Set temperature for auxiliary heat On</th> <th>Time delay for auxiliary heat On</th> </tr> </thead> <tbody> <tr><td>0: No temperature offset</td><td>No delay</td></tr> <tr><td>1: No temperature offset</td><td>10 minutes</td></tr> <tr><td>2: No temperature offset</td><td>20 minutes</td></tr> <tr><td>3: 2.7°F (1.5°C)</td><td>No delay</td></tr> <tr><td>4: 2.7°F (1.5°C)</td><td>10 minutes</td></tr> <tr><td>5: 2.7°F (1.5°C)</td><td>20 minutes</td></tr> <tr><td>6: 5.4°F (3.0°C)</td><td>No delay</td></tr> <tr><td>7: 5.4°F (3.0°C)</td><td>10 minutes</td></tr> <tr><td>8: 5.4°F (3.0°C)</td><td>20 minutes</td></tr> <tr><td>9: 8.1°F (4.5°C)</td><td>No delay</td></tr> <tr><td>A: 8.1°F (4.5°C)</td><td>10 minutes</td></tr> <tr><td>B: 8.1°F (4.5°C)</td><td>20 minutes</td></tr> <tr><td>C: 10.8°F (6.0°C)</td><td>No delay</td></tr> <tr><td>D: 10.8°F (6.0°C)</td><td>10 minutes</td></tr> <tr><td>E: 10.8°F (6.0°C)</td><td>20 minutes</td></tr> </tbody> </table> <p><b>Note:</b> If further temperature offsets are desired, contact technical support.</p>	Set temperature for auxiliary heat On	Time delay for auxiliary heat On	0: No temperature offset	No delay	1: No temperature offset	10 minutes	2: No temperature offset	20 minutes	3: 2.7°F (1.5°C)	No delay	4: 2.7°F (1.5°C)	10 minutes	5: 2.7°F (1.5°C)	20 minutes	6: 5.4°F (3.0°C)	No delay	7: 5.4°F (3.0°C)	10 minutes	8: 5.4°F (3.0°C)	20 minutes	9: 8.1°F (4.5°C)	No delay	A: 8.1°F (4.5°C)	10 minutes	B: 8.1°F (4.5°C)	20 minutes	C: 10.8°F (6.0°C)	No delay	D: 10.8°F (6.0°C)	10 minutes	E: 10.8°F (6.0°C)	20 minutes
Set temperature for auxiliary heat On	Time delay for auxiliary heat On																																		
0: No temperature offset	No delay																																		
1: No temperature offset	10 minutes																																		
2: No temperature offset	20 minutes																																		
3: 2.7°F (1.5°C)	No delay																																		
4: 2.7°F (1.5°C)	10 minutes																																		
5: 2.7°F (1.5°C)	20 minutes																																		
6: 5.4°F (3.0°C)	No delay																																		
7: 5.4°F (3.0°C)	10 minutes																																		
8: 5.4°F (3.0°C)	20 minutes																																		
9: 8.1°F (4.5°C)	No delay																																		
A: 8.1°F (4.5°C)	10 minutes																																		
B: 8.1°F (4.5°C)	20 minutes																																		
C: 10.8°F (6.0°C)	No delay																																		
D: 10.8°F (6.0°C)	10 minutes																																		
E: 10.8°F (6.0°C)	20 minutes																																		
N/A	19	Factory set to 3.	Cannot be changed. Not seen in configuration mode.																																

**Table 2. Installation option #2: Digit 2 = 5**

Display screen (mode and On/Off)	Digit	Option description	Set digit to...	
	23	Forcing fan operation for heating and cooling	<b>Cooling: Fan Setting</b> 0: Disabled 1: Disabled 2: Disabled 3: Disabled 4: Enabled (Fan: user setting) 5: Enabled (Fan: user setting) 6: Enabled (Fan: user setting) 7: Enabled (Fan: user setting) 8: Enabled (Fan: High) 9: Enabled (Fan: High) A: Enabled (Fan: High) B: Enabled (Fan: High) C: Enabled (Fan: Low) D: Enabled (Fan: Low) E: Enabled (Fan: Low) F: Enabled (Fan: Low)	<b>Heating: Fan Setting</b> Disabled Enabled (Fan: User setting) Enabled (Fan: High) Enabled (Fan: Low) Disabled Enabled (Fan: User setting) Enabled (Fan: High) Enabled (Fan: Low) Disabled Enabled (Fan: User setting) Enabled (Fan: High) Enabled (Fan: Low) Disabled Enabled (Fan: User setting) Enabled (Fan: High) Enabled (Fan: Low)

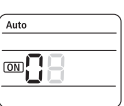
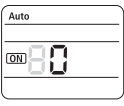
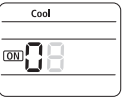
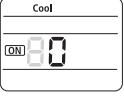
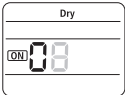
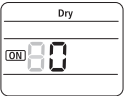
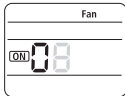
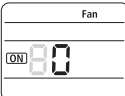
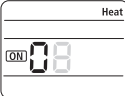
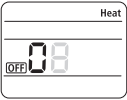
- (a) Up to 8 IDUs can be accommodated on a single MCU port under the following conditions: IDUs cannot exceed 54 MBH, mode master control must be used, wired controllers must be used.
- (b) Cooling Only operation (HR only) must be selected on HR systems that have a direct connection (no MCU) to main liquid and gas lines.
- (c) Height difference between the indoor unit being configured and the lowest indoor unit is > 98.4 ft (30 m), or pipe length difference between the outdoor unit and the furthest indoor unit and the outdoor unit and the indoor unit being configured is > 360.9 ft (110 m).
- (d) Height difference between the indoor unit being configured and the lowest indoor unit is 49.2–98.4 ft (15–30 m), or pipe length difference between the outdoor unit and the furthest indoor unit and the outdoor unit and the indoor unit being configured is 164–360.9 ft (50–110 m).  
**Example:** If the unit being configured is 60 ft away from the outdoor unit, and the furthest indoor unit is 300 ft from the outdoor unit, the pipe length difference is 240 ft (300-60=240), so Digit 10 should be set to "2."
- (e) Heater operation when Installation Option #1 digit 15 is set to enable external heater. Using Installation Option #2, set digit 18 to desired offset (see external contact control board installation instructions: VRF-SVN54\*).

Figure 7. Heat recovery unit operating in Auto Changeover mode

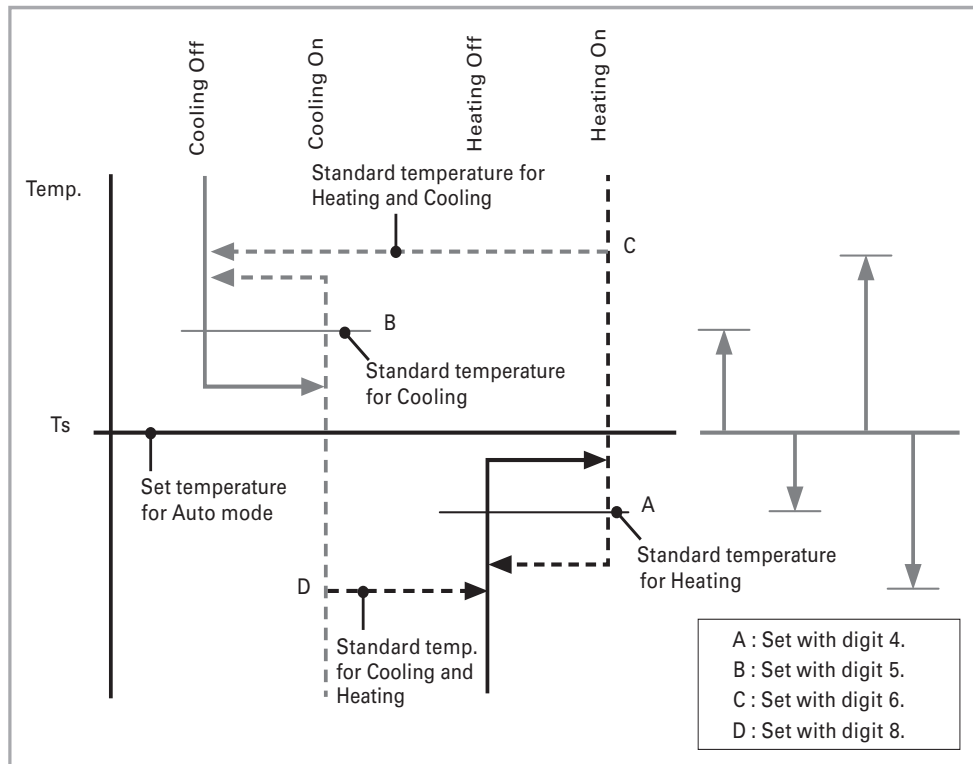

Note: Minimum compressor off time for heating or cooling is set by digit 9.

# Operation

Familiarize yourself with the unit components and operating tips before operating the unit.

## Components

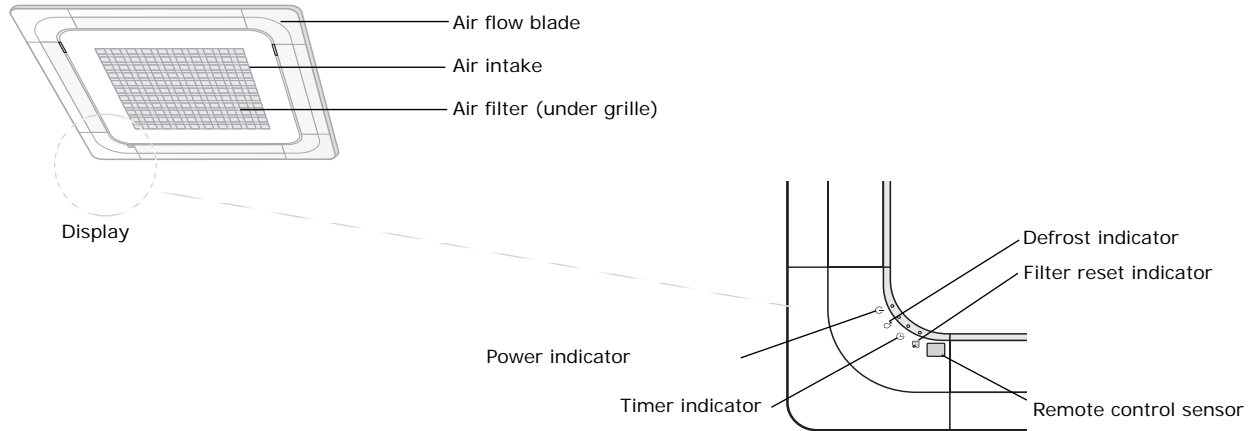

**Note:** Your unit and display may look slightly different from the illustration shown above, depending on your model.

## Operating Tips

Follow these tips when using your unit:

<b>Cooling</b>	If the outside temperature is much higher than the selected indoor temperature, it may take longer than expected to achieve the desired temperature. Avoid making extreme changes in the temperature setting. This practice wastes energy and does not cool the room faster.
<b>Heating</b>	Because the unit heats the room by removing heat energy from outdoor air, the heating capacity may decrease when outdoor temperatures are extremely low. If the unit provides insufficient heat, use an additional heating source in combination with the unit.
<b>Defrost</b>	When the unit runs in Heat mode, frost may form due to the temperature difference between the unit and the outside air. If this happens: <ul style="list-style-type: none"> <li>• The unit stops heating.</li> <li>• The unit will operate automatically in Defrost mode for 10 minutes.</li> <li>• The steam produced on the outdoor unit in Defrost mode is safe.</li> </ul> No intervention is required; after about 10 minutes, the unit will resume normal operation. The unit will not operate when it starts to defrost.
<b>Fan</b>	The fan may not operate for 3–5 minutes after turning on the unit, to prevent cold air from blowing on occupants while the unit is warming up.
<b>High indoor and outdoor temperatures</b>	If both indoor and outdoor temperatures are high and the unit is running in Heat mode, the outdoor unit fan and compressor may stop at times. This is normal; wait until the unit turns on again.
<b>Power failure</b>	A power failure will cause the unit to stop operating. When power returns, the unit will automatically resume operation.
<b>Minimum Off Timer</b>	If the unit has just been turned on, it will not produce cool/warm air for 3 minutes. This delay mechanism protects the outdoor unit compressor.



## Internal Protections

Internal protections operate if an internal fault occurs in the unit.

Type	Description
Cold air dump	The internal fan will be off to prevent a cold air dump when the heat pump is in defrost mode.
Defrost cycle	The internal fan will be off to prevent a cold air dump when the heat pump is in defrost mode.
Anti-short cycle timer	The compressor observes a 3-minute off time when cycling power to the unit or after an outage.

**Note:** If the heat pump is operating in Heat mode, a defrost cycle is activated to remove frost from an outdoor unit that may have accumulated at low temperatures. The internal fan is switched off automatically and restarted only after the defrost cycle is completed.

## Operating Ranges

For efficient use, operate the unit within the ranges shown in this table.

Mode	Outdoor temperature	Indoor temperature	Indoor humidity
Cooling	23°F (-5°C) to 118°F (48°C)	64°F (18°C) to 90°F (32°C)	80% or less
Heating	-4°F (-20°C) to 75°F (24°C)	81°F (27°C) or less	—
Drying	23°F (-5°C) to 118°F (48°C)	64°F (18°C) to 90°F (32°C)	—

**Note:** The standard temperature for heating is 45°F (7°C). If the outdoor temperature drops to 32°F (0°C) or below, the heating capacity can be reduced depending on the temperature condition. If the indoor cooling temperature is set higher than 90°F (32°C), the unit will not cool to its full capacity.

## Operating Mode for Heat Pump Systems

For heat pump systems, the main indoor unit controls whether the system operates in heating or cooling. If the main indoor unit calls for heating and sub-indoor units call for cooling, the main indoor unit (and any other sub-indoor units that call for heating) will operate in heating mode, and the sub-indoor units that call for cooling will do nothing.

## Maintenance

### Cleaning the Exterior

#### **NOTICE**

**Avoid equipment damage and risk of fire!**

**Avoid using benzene or other flammable solvents. They may damage the surface of the unit and increase the potential for fire.**

Use a dry or damp cloth to wipe the surface of the unit as needed. If necessary, use mild soap and water on a damp cloth. Use a soft brush to remove dirt from the grille.

## Cleaning the Grille and Air Filter

1. Pull the grille downward by using the tabs on the edge of the grille (see illustration). Two safety clips will prevent it from dropping.

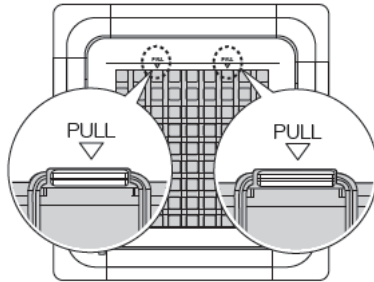

2. Detach the grille by removing the two safety clip from the front panel. To clean only the filter, proceed to step 4.



3. Pull out the air filter.

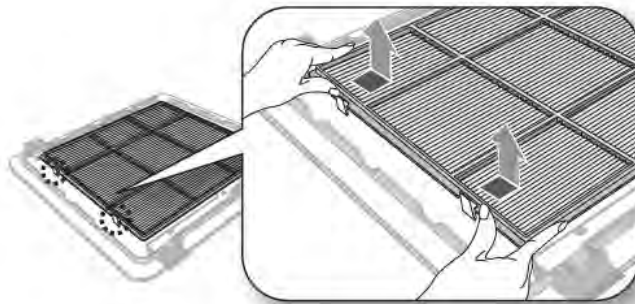

4. Clean the grille and air filter with a vacuum or soft brush. If the dust is too thick, rinse them under running water and dry in a well-ventilated area.

**Note:** Drying the air filter in a confined or humid area may cause odors to develop. If odors occur, re-clean and dry it in a well-ventilated area.

5. Replace the air filter in its original position. The air filter will click when it is in the proper position.
6. After cleaning the air filter, press the **Filter Reset** button on the remote control for 2 seconds to reset the filter schedule. The filter indicator lights when it is time the clean the filter again.
7. Replace the grille by reversing the first three steps.

**Note:** If the angle on the air flow blades changed from opening the grille, turn the circuit breaker off and on again to restore the blades to their proper angle.

## Periodic Maintenance Checks

Refer to the schedule given in [Table 3](#) for proper unit maintenance.

**Note:** If the unit will not be used for an extended period of time, operate it in Fan mode for 3–4 hours to thoroughly dry it and then disconnect the power plug. Moisture left in the components can cause odors and internal damage.

**Table 3. Maintenance schedule**

Description	Monthly	Every 4 months	Once a year	As needed
Clean the air filter <sup>(a)</sup>	x			
Clean the condensate drain pan <sup>(b)</sup>			x	
Thoroughly clean the heat exchanger <sup>(b)</sup>			x	
Clean the condensate drain pipe <sup>(b)</sup>		x		
Replace remote control batteries <sup>(a)</sup>				x

(a) The described operations should be performed more frequently if the area of installation is very dusty.

(b) These operations must always be performed by qualified personnel. For more detailed information, see the installation manual for this unit.

## Error Codes

As a protection strategy, the unit will stop operating if an error code is generated. If the unit is turned on before the problem is resolved, the error code will re-appear and the unit will stop operating again.

For interpreting error codes, refer to the list of error codes in the Technician Utilities Tool (TUT) or the Service Manual for VRF Outdoor and Indoor Units (VRF-SVM046\*).

## Troubleshooting

Refer to the following table for solutions to common problems.

**Table 4. Solutions to common problems**

Problem	Solution
The unit does not operate immediately after restarting it.	The anti-short cycle timer prevents the unit from operating immediately to keep it from overloading. The unit will start in 3 minutes.
The unit does not operate.	Verify the following: The power plug is properly inserted into the wall receptacle. There has not been a power failure. The circuit breaker is switched on/fuses are good.
The temperature does not change.	Verify that the unit is not operating in Fan mode. If it is, select a different mode.
The unit is not producing warm/cool air.	Verify the following: Temperature setting on remote control is higher/lower than the current temperature. Air filter is not clogged with dirt. If the unit has just been turned on, wait 3 minutes for the anti-short cycle timer to expire. Air flow is unobstructed. Line size and length is correct and does not exceed factory recommendations. Operating mode is heat/cool. If unit is not producing warm air, is it set to Cool mode? Remote control is not for a cooling-only unit. That the unit has not been installed in direct sunlight. If so, hang curtains or shades on windows to filter the sun and increase unit efficiency.

**Table 4. Solutions to common problems**

<b>Problem</b>	<b>Solution</b>
The fan speed does not change.	Verify that Auto or Dry mode is selected. Either of these modes automatically adjust the fan speed.
Timer function does not work.	Press the Power button on the remote control after setting the time.
Odors permeate the room during operation.	Verify the origin of the odor. Operate the unit in Fan mode or open the windows to air out the room.
The unit makes a bubbling sound	A bubbling sound may be heard when the refrigerant is circulating through the indoor unit during certain system operating conditions, which should normally be of short duration.
Water is dripping from the air flow blades.	If the unit has been running for an extended period of time with the blades fully open, adjust the blades to mid-position to alleviate condensation formation.
The remote control is not working.	Verify that: Batteries are not depleted. Batteries are correctly installed. Nothing is blocking the remote control sensor. No strong fluorescent or neon lighting is near the unit, which may interrupt the signal.
The unit does not turn on/off with the wired remote control.	Ensure that the wired remote control is not set for Group Control.
Indicators on the digital display flash.	Press the Power button on the remote control to turn the unit off. Then switch the circuit break off and then on again.

Ingersoll Rand (NYSE:IR) advances the quality of life by creating comfortable, sustainable and efficient environments. Our people and our family of brands—including Club Car®, Ingersoll Rand®, Thermo King® and Trane®—work together to enhance the quality and comfort of air in homes and buildings; transport and protect food and perishables; and increase industrial productivity and efficiency. We are a global business committed to a world of sustainable progress and enduring results. For more information, visit [www.ingersollrand.com](http://www.ingersollrand.com).

has a policy of continuous product and product data improvement and reserves the right to change design and specifications without notice.