

DRAWING	REVISION	VERSION
	A	1

UNLESS OTHERWISE SPECIFIED ALL DIMENSIONS ARE IN INCHES. TOLERANCE:

.X =± 0.0
 .XX =± 0.00
 .XXX =± 0.030

ANGLES =± 3.0 ° HOLE DIA = + .005
 - .005

CONFORMS TO ASME Y14.5M-1994.

FINISH ✓

TRANE

THIS DRAWING IS PROPRIETARY AND SHALL NOT BE COPIED OR ITS CONTENTS DISCLOSED TO OUTSIDE PARTIES WITHOUT THE WRITTEN CONSENT OF TRANE

DRAWN BY: R.Frame © TRANE DATE: 18-May-11

DO NOT SCALE PRINT

THIRD ANGLE PROJECTION

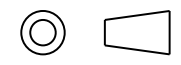

49531537 SHEET 1 OF 1 REV **A**

GUARD COVER

M:GV L:5.114 W:3.408 T:0.044

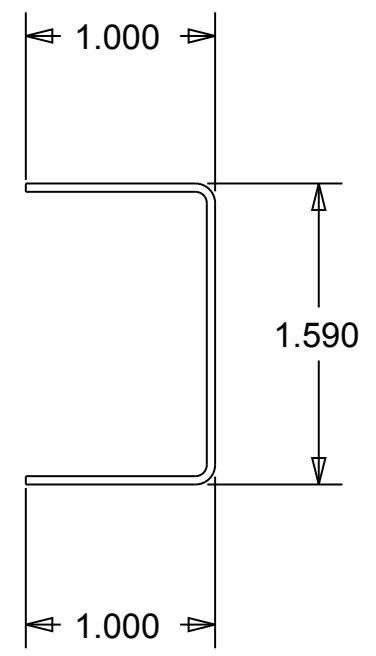
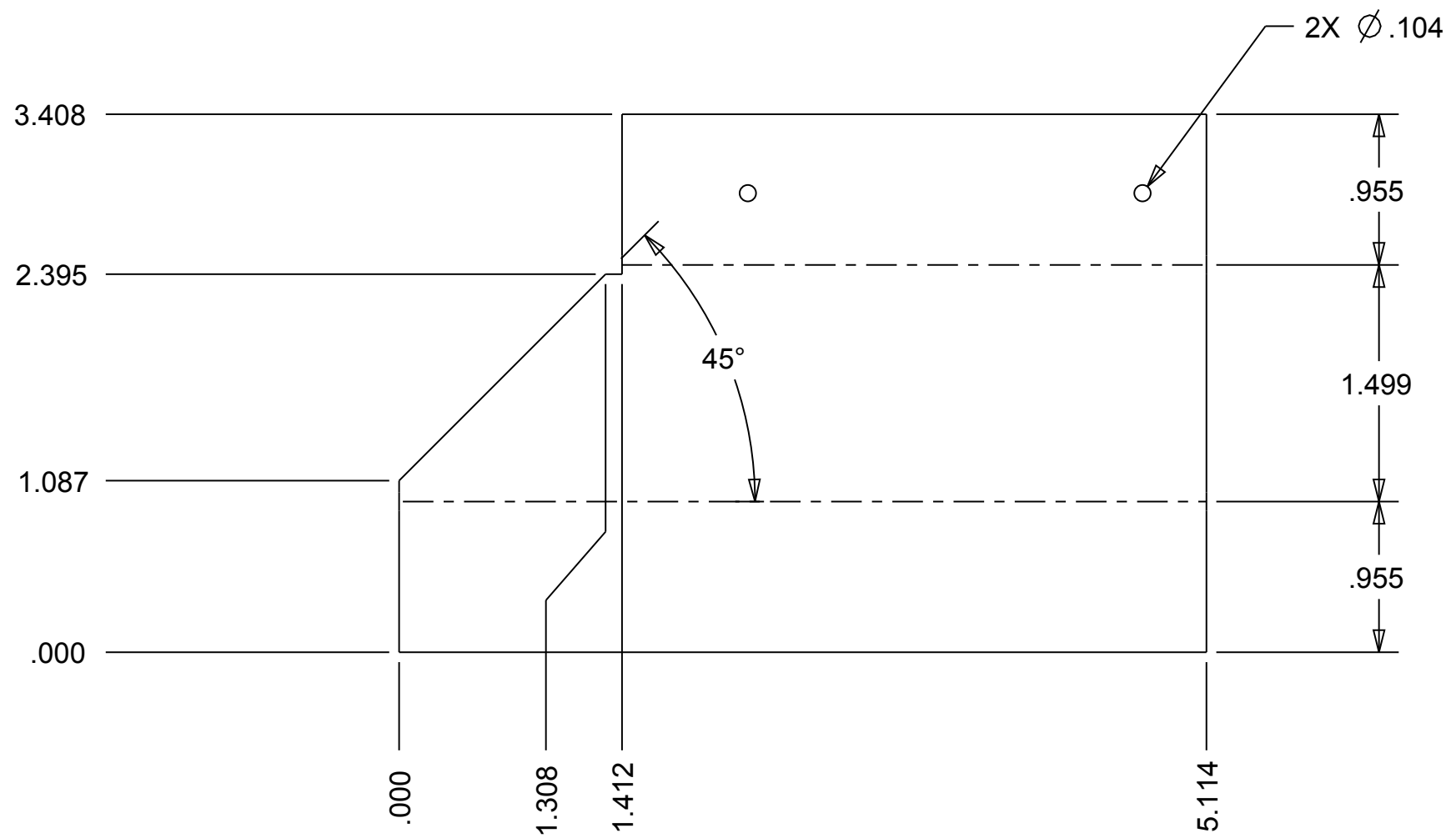
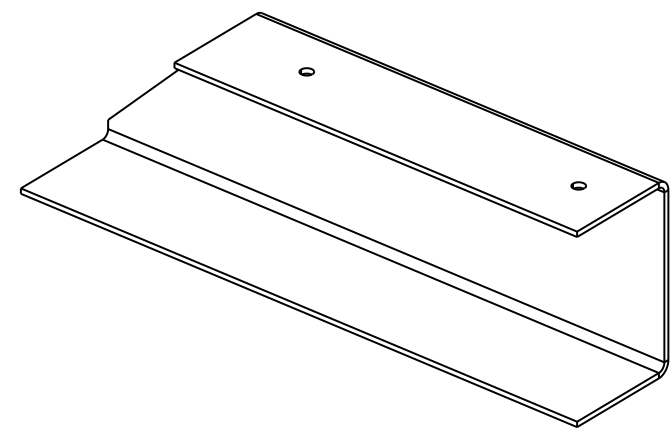
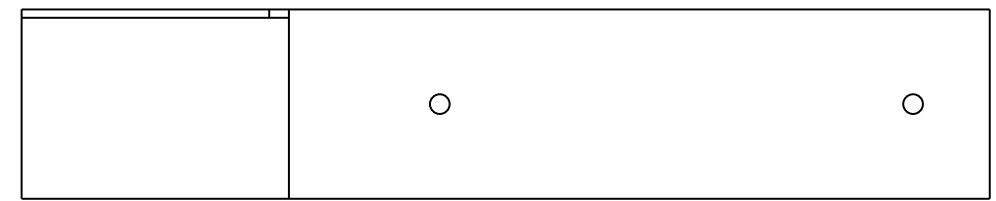

B

A

4

3

2

1